

### Features

- 30V/30A,  
 $R_{DS(ON)} = 6m\Omega(Typ.)@V_{GS}=10V$   
 $R_{DS(ON)} = 9.5m\Omega(Typ.)@V_{GS}=4.5V$
- Ultra Low On-Resistance
- Fast Switching Speed
- 100% avalanche tested
- Lead Free and Green Devices Available (RoHS Compliant)

### Applications

- DC/DC Converters
- On board power for server
- Synchronous rectification

### Pin Description

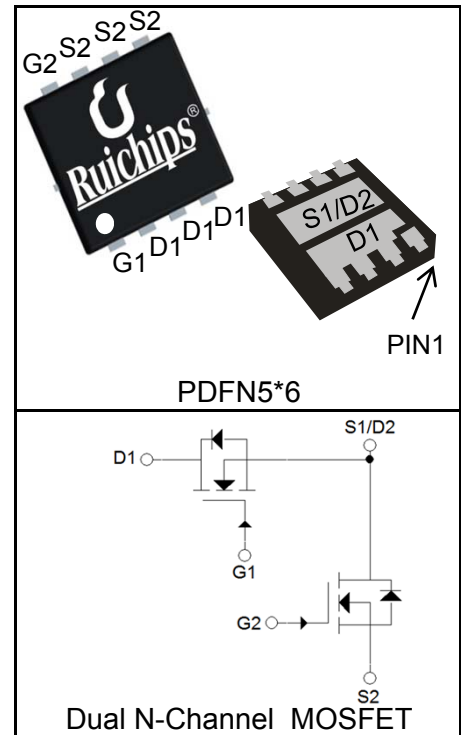

### Absolute Maximum Ratings

Symbol	Parameter	Rating	Unit
<b>Common Ratings</b> ( $T_C=25^\circ C$ Unless Otherwise Noted)			
$V_{DSS}$	Drain-Source Voltage	30	V
$V_{GSS}$	Gate-Source Voltage	$\pm 20$	
$T_J$	Maximum Junction Temperature	150	$^\circ C$
$T_{STG}$	Storage Temperature Range	-55 to 150	$^\circ C$
$I_S$	Diode Continuous Forward Current	$T_C=25^\circ C$ 20	A
<b>Mounted on Large Heat Sink</b>			
$I_{DP}^{①}$	300 $\mu s$ Pulse Drain Current Tested	$T_C=25^\circ C$ 120	A
$I_D^{②}$	Continuous Drain Current@ $T_C(V_{GS}=10V)$	$T_C=25^\circ C$ 30	A
		$T_C=100^\circ C$ 19	
	Continuous Drain Current@ $T_A(V_{GS}=10V)^{③}$	$T_A=25^\circ C$ 11	
		$T_A=70^\circ C$ 9	
$P_D$	Maximum Power Dissipation@ $T_C$	$T_C=25^\circ C$ 29	W
		$T_C=100^\circ C$ 12	
	Maximum Power Dissipation@ $T_A^{③}$	$T_A=25^\circ C$ 3.5	
		$T_A=70^\circ C$ 2.3	

Symbol	Parameter	Rating	Unit
$R_{\theta JC}$	Thermal Resistance-Junction to Case	4.2	°C/W
$R_{\theta JA}$ <sup>③</sup>	Thermal Resistance-Junction to Ambient	42	°C/W
<b>Drain-Source Avalanche Ratings</b>			
$E_{AS}$ <sup>④</sup>	Avalanche Energy, Single Pulsed	49	mJ

**Electrical Characteristics** ( $T_C=25^\circ\text{C}$  Unless Otherwise Noted)

Symbol	Parameter	Test Condition	RUH30J30M			Unit
			Min.	Typ.	Max.	
<b>Static Characteristics</b>						
$BV_{DSS}$	Drain-Source Breakdown Voltage	$V_{GS}=0V, I_{DS}=250\mu A$	30			V
$I_{DSS}$	Zero Gate Voltage Drain Current	$V_{DS}=30V, V_{GS}=0V$			1	$\mu A$
		$T_J=125^\circ\text{C}$			30	
$V_{GS(th)}$	Gate Threshold Voltage	$V_{DS}=V_{GS}, I_{DS}=250\mu A$	1		2.5	V
$I_{GSS}$	Gate Leakage Current	$V_{GS}=\pm 20V, V_{DS}=0V$			$\pm 100$	nA
$R_{DS(ON)}$ <sup>⑤</sup>	Drain-Source On-state Resistance	$V_{GS}=10V, I_{DS}=30A$		6	8	$m\Omega$
		$V_{GS}=4.5V, I_{DS}=20A$		9.5	12	$m\Omega$
<b>Diode Characteristics</b>						
$V_{SD}$ <sup>⑤</sup>	Diode Forward Voltage	$I_{SD}=30A, V_{GS}=0V$			1.2	V
$t_{rr}$	Reverse Recovery Time	$I_{SD}=30A, di_{SD}/dt=100A/\mu s$		15		ns
$Q_{rr}$	Reverse Recovery Charge			8		nC
<b>Dynamic Characteristics</b> <sup>⑥</sup>						
$R_G$	Gate Resistance	$V_{GS}=0V, V_{DS}=0V, F=1\text{MHz}$		1.2		$\Omega$
$C_{iss}$	Input Capacitance	$V_{GS}=0V,$ $V_{DS}=15V,$ Frequency=1.0MHz		470		pF
$C_{oss}$	Output Capacitance			130		
$C_{rss}$	Reverse Transfer Capacitance			19		
$t_{d(ON)}$	Turn-on Delay Time	$V_{DD}=15V, R_L=0.47\Omega,$ $I_{DS}=30A, V_{GEN}=10V,$ $R_G=0.8\Omega$		4		ns
$t_r$	Turn-on Rise Time			10		
$t_{d(OFF)}$	Turn-off Delay Time			14		
$t_f$	Turn-off Fall Time			5		
<b>Gate Charge Characteristics</b> <sup>⑥</sup>						
$Q_g$	Total Gate Charge	$V_{DS}=24V, V_{GS}=10V,$ $I_{DS}=30A$		12		nC
$Q_{gs}$	Gate-Source Charge			3		
$Q_{gd}$	Gate-Drain Charge			4		

**Notes:**

- ① Pulse width limited by safe operating area.
- ② Calculated continuous current based on maximum allowable junction temperature.
- ③ When mounted on 1 inch square copper board,  $t \leq 10\text{sec}$ .
- ④ Limited by  $T_{J\text{max}}$ ,  $I_{AS} = 14\text{A}$ ,  $V_{DD} = 24\text{V}$ ,  $R_G = 50\Omega$ , Starting  $T_J = 25^\circ\text{C}$ .
- ⑤ Pulse test; Pulse width  $\leq 300\mu\text{s}$ , duty cycle  $\leq 2\%$ .
- ⑥ Guaranteed by design, not subject to production testing.

**Ordering and Marking Information**

<b>Device</b>	<b>Marking</b>	<b>Package</b>	<b>Packaging</b>	<b>Quantity</b>	<b>Reel Size</b>	<b>Tape width</b>
RUH30J30M	RUH30J30M	PDFN5060	Tape&Reel	3000	13"	12mm

**Typical Characteristics**

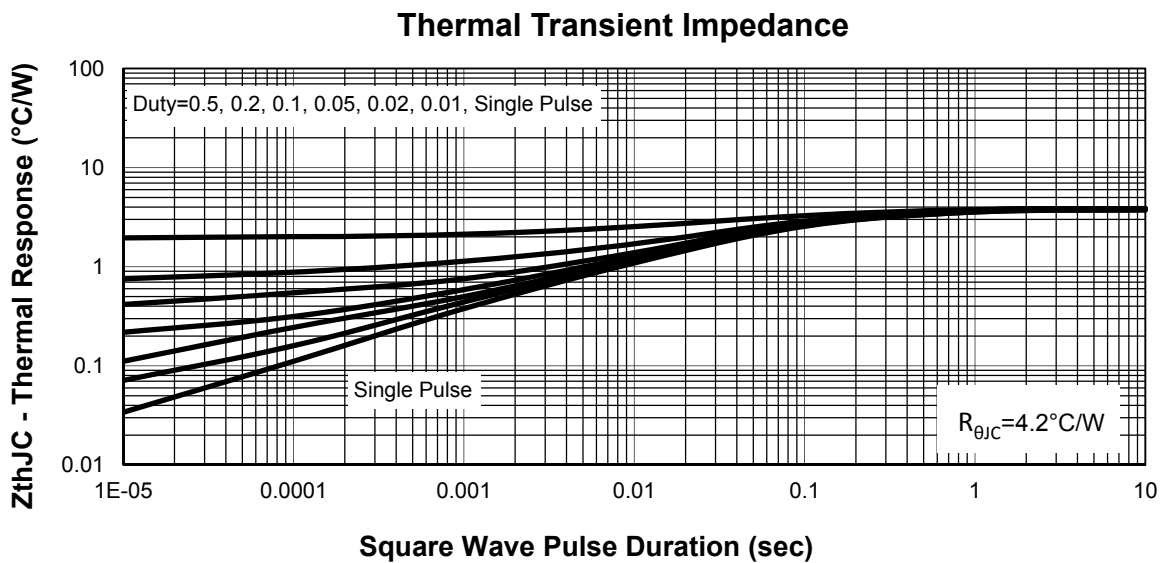
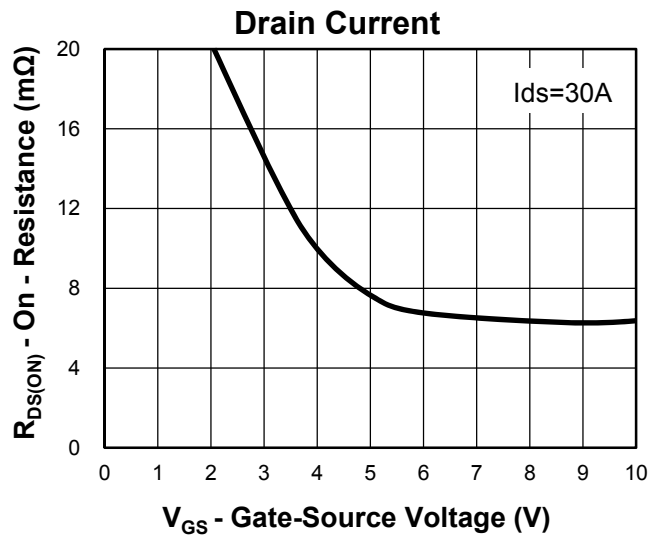
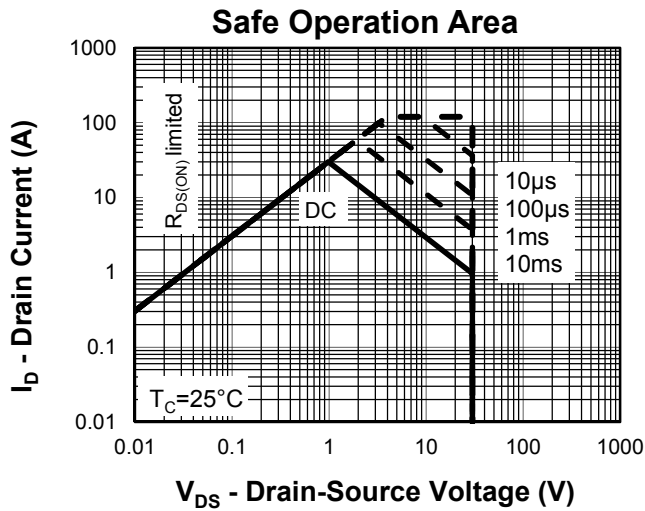
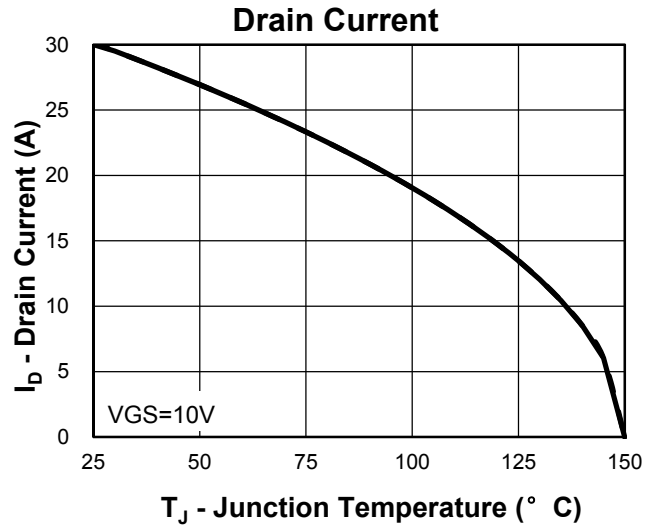
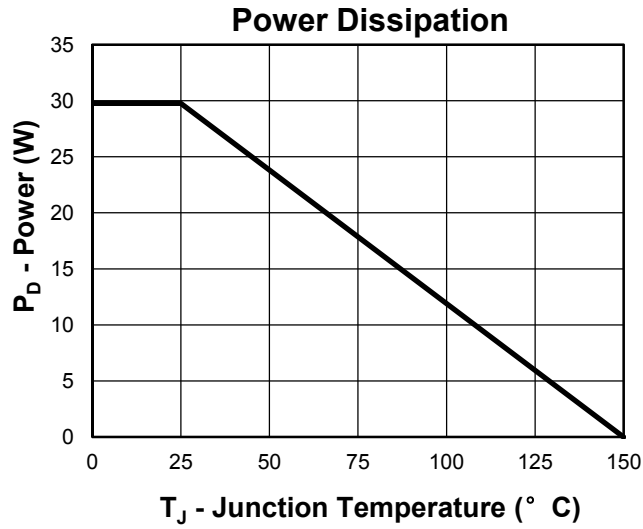

**Typical Characteristics**

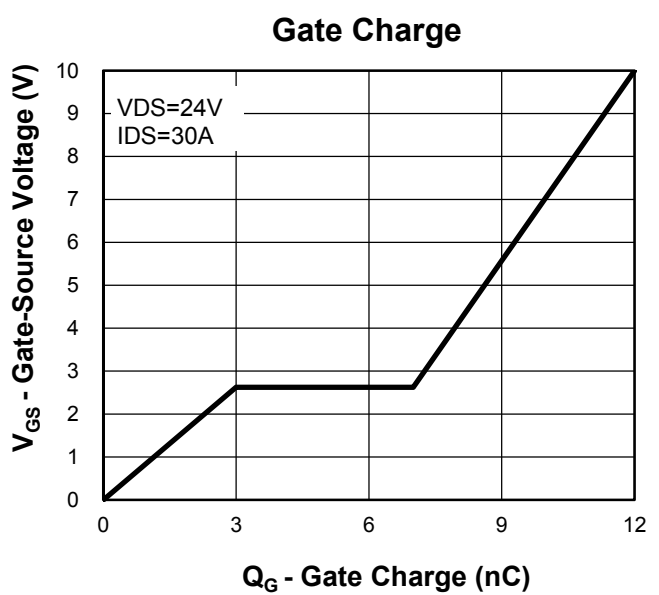
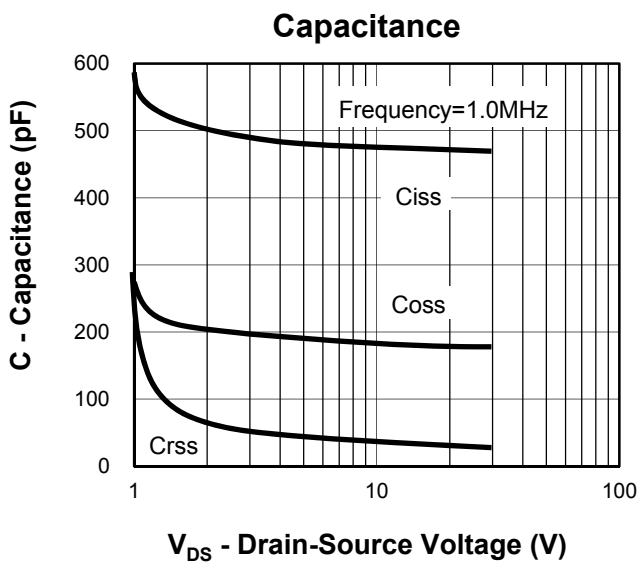
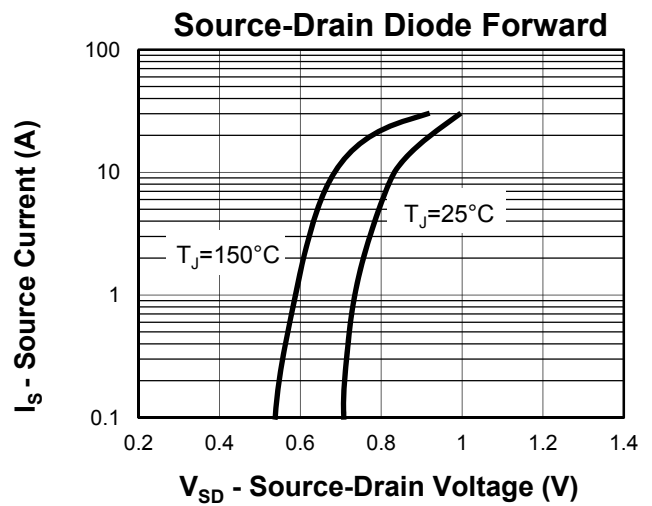
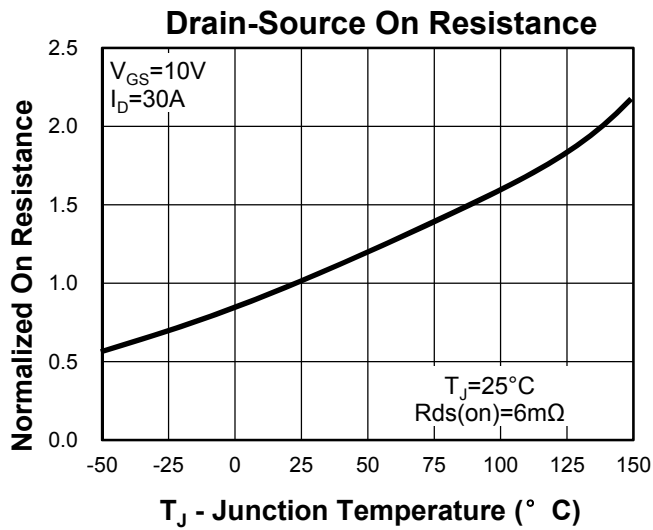
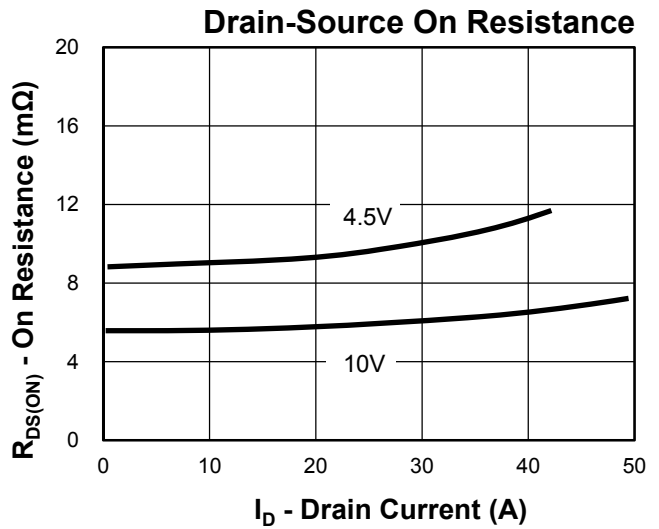
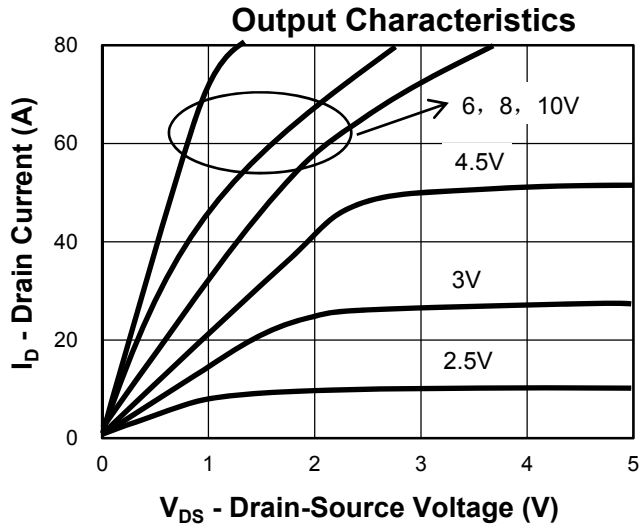

**Avalanche Test Circuit and Waveforms**

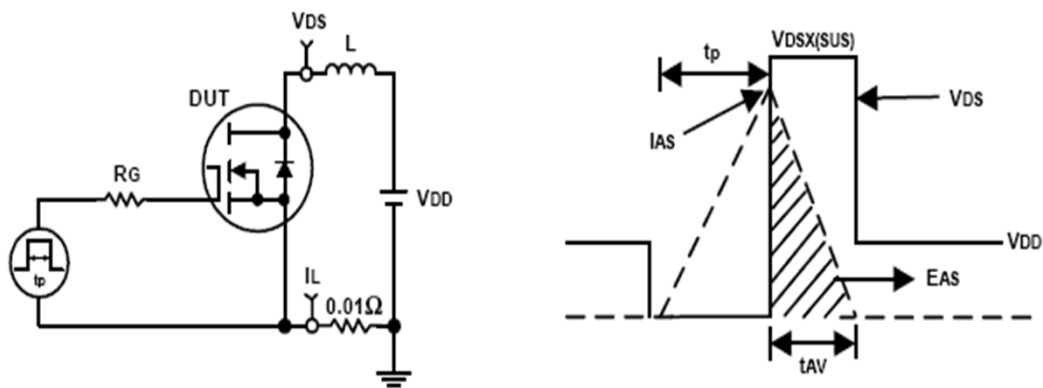

**Switching Time Test Circuit and Waveforms**

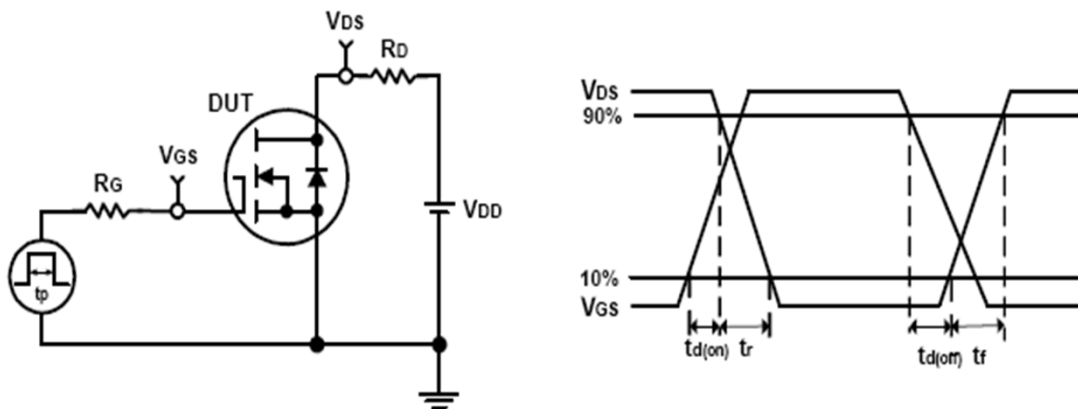

**Package Information**

**PDFN5060**

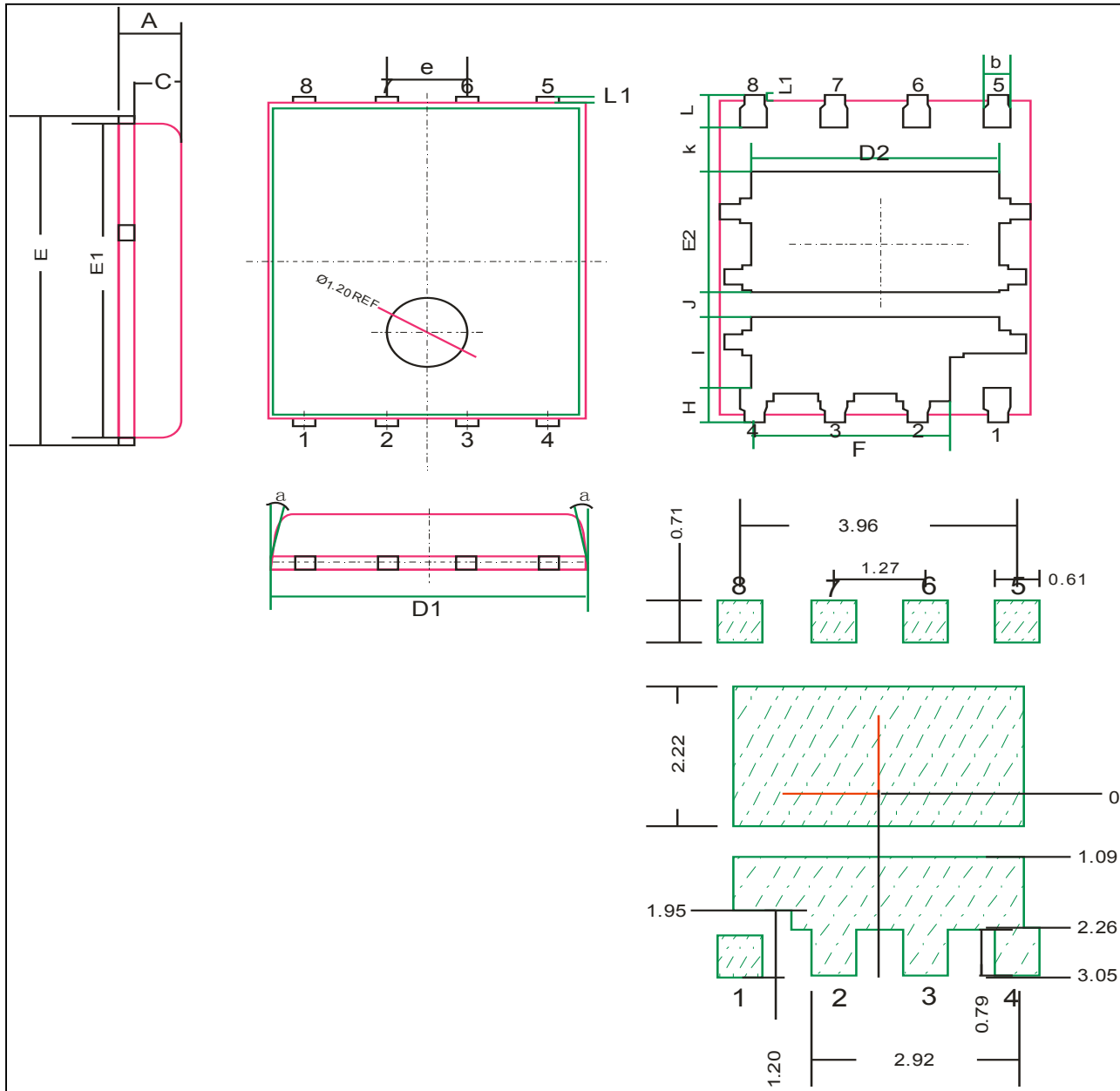

SYMBOL	MM			INCH			SYMBOL	MM			INCH		
	MIN	NOM	MAX	MIN	NOM	MAX		MIN	NOM	MAX	MIN	NOM	MAX
A	0.90	1.00	1.10	0.035	0.039	0.043	E1	5.70	5.75	5.80	0.224	0.226	0.228
b	0.33	0.41	0.51	0.013	0.016	0.020	E2	2.02	2.17	2.32	0.079	0.085	0.091
c	0.20	0.25	0.30	0.008	0.010	0.012	e	1.27BSC			0.05BSC		
D1	4.80	4.90	5.00	0.189	0.193	0.197	H	0.48	0.58	0.68	0.018	0.022	0.026
D2	3.61	3.81	3.96	0.142	0.150	0.156	L	0.51	0.61	0.71	0.020	0.024	0.028
L1	0.06	0.13	0.20	0.002	0.005	0.008							
E	5.90	6.00	6.10	0.232	0.236	0.240	@	0°	*	12°	*	10°	12°
K	0.50	*	*	0.019	*	*	J	0.40	0.50	0.60	0.015	0.019	0.023
I	1.22	1.32	1.42	0.048	0.051	0.055	F	2.87	3.07	3.22	0.112	0.12	0.126

**Customer Service****Worldwide Sales and Service:**

Sales@ruichips.com

**Technical Support:**

Technical@ruichips.com

**Investor Relations Contacts:**

Investor@ruichips.com

**Marcom Contact:**

Marcom@ruichips.com

**Editorial Contact:**

Editorial@ruichips.com

**HR Contact:**

HR@ruichips.com

**Legal Contact:**

Legal@ruichips.com

**Shen Zhen RUICHIPS Semiconductor CO., LTD**

4th Floor, Block 8, Changyuan New Material Port, Keyuan Middle Road, Science & Industry Park,  
Nanshan District, Shenzhen, CHINA

**TEL:** (86-755) 8311-5334

**FAX:** (86-755) 8311-4278

**E-mail:** Sales-SZ@ruichips.com